

CONTROL EQUIPMENT

DYA-T07

DIGITAL CONTROL BOX 380V



QUANTUM PUMPS

— BEYOND BOUNDARIES —



PUMP CONTROLLER

DYA-T07 Series



General description

This three phase analogue control panel is design to operate with units ranging from 9.2 - 15kW, 380V. It will control and protect pump motors in the following capacity:

1. Under and over voltage
2. Pump stalled
3. Over current
4. Dry run

Technical information

Power Output	9.2 - 30kW
Voltage	380V
Trip response time of overload	5 sec - 5min
Trip response time of open phase	< 2 sec
Trip response time of short circuit	0.1 sec
Trip response time of under/over voltage	5 sec
Trip response time of dry run	6 sec
Recovery time of over load	30 min
Recovery time of under/over voltage	5 min
Recovery time of dry run	30 min
Trip voltage of over voltage	115% of rated input voltage
Trip voltage of under voltage	80% of rated input voltage
Protection functions	Dry run
Degree of protection	IP54

QUANTUM PUMPS
BEYOND BOUNDARIES

PUMP CONTROLLER

DYA-T07 Series



LCD Display

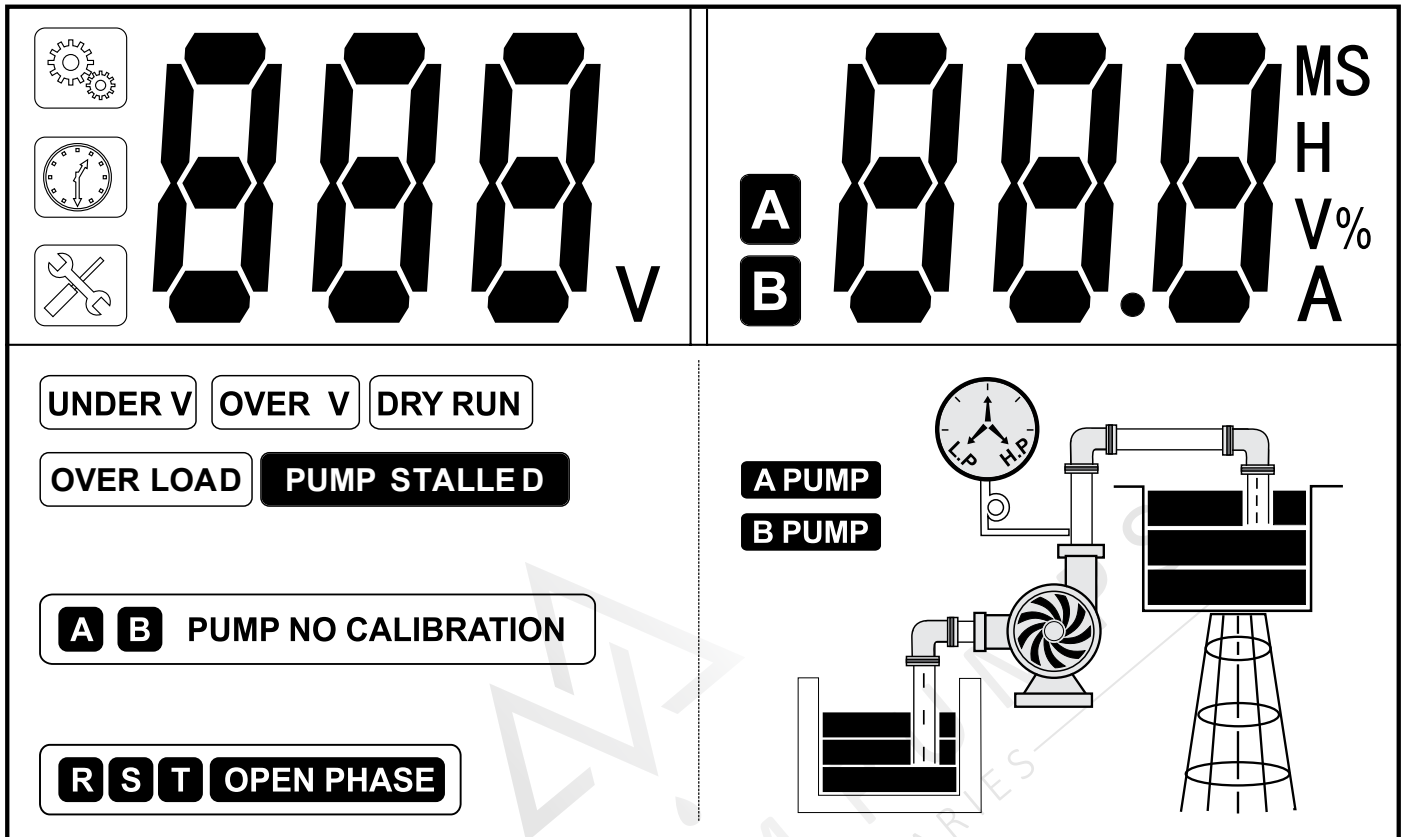

Wiring Diagram

INCOMING POWER SUPPLY

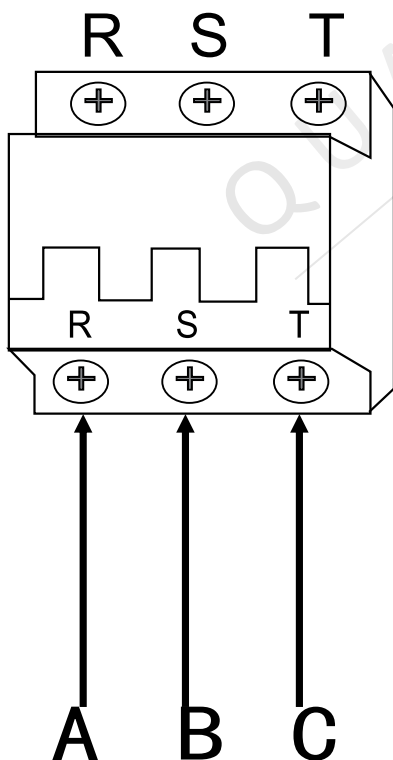

POWER SUPPLY TO OPERATING UNIT

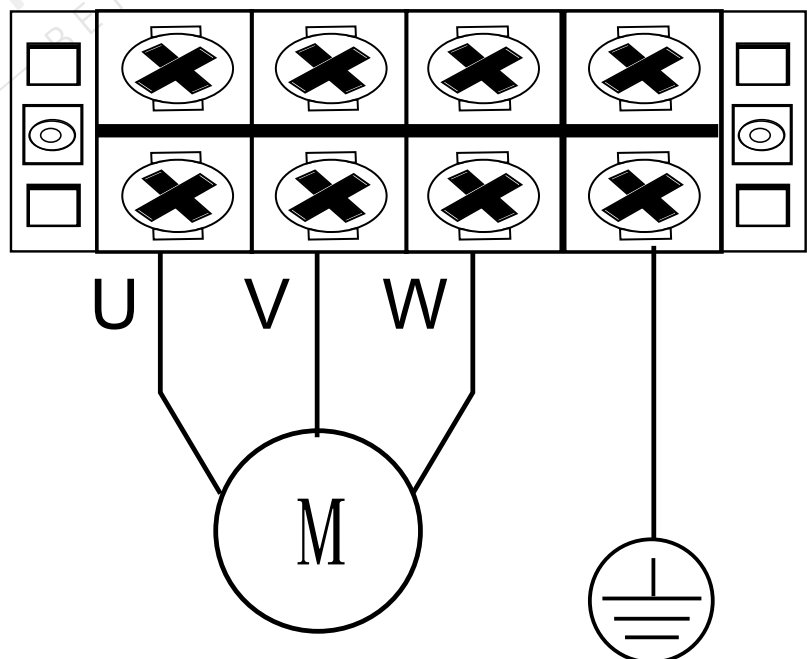

PUMP CONTROLLER

DYA-T07 Operational Instructions



Calibration and removal of parameters.

Parameter Calibration

It is essential that the parameter calibration is done promptly after pump installation has been completed to ensure accurate parameter setting for pre-eminent protection and performance.

Ensure that the pump is primed or submerged prior to calibration to ensure accurate calibration. If the unit does not have efficient liquid supply the overload and pump stalled errors may occur after completion of the parameter calibration.

STEP 1

Press the **START** key to switch the operating unit ON. Ensure all system components are working accurately, including LCD display of the control unit.

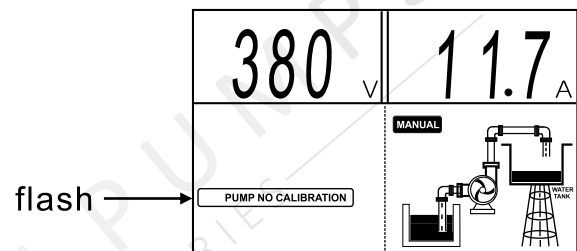

STEP 2

Press the **STORE** key, you will hear a beep sound and the timer will start counting down.

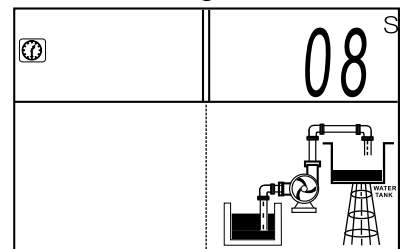

STEP 3

After completion of countdown the operating unit will stop running, once the operating unit has come to a complete stop the parameter calibration of the control box will be set.

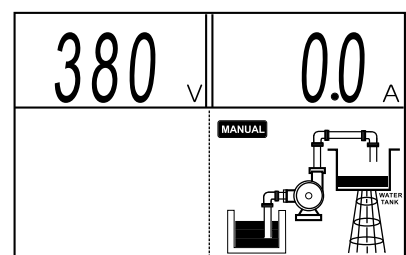

PUMP CONTROLLER

DYA-T07 Operational Instructions



Resetting the parameter calibration settings.

Ensure the operating unit is not running and the control unit is in STOP status. Press the **START** button and hold until you hear a beep sound. Once you hear the beep sound the calibration parameter will be reset.

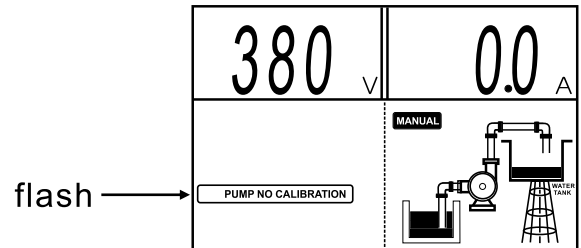

Failure records.

The DYA-T07 control panel is equipped with a failure recording analyzer that records the last 5 failures. This function gives you the capability to monitor the operational conditions to ensure the unit is running and operating at the designed condition. Follow the proper trouble shooting steps to resolve all error codes to prevent re-occurrence of a failure.

Resetting the failure recordings.

Press the **STOP** and **MODE** button simultaneously and hold until you hear a beep sound. Once you hear the beep sound the failure recordings will be reset.

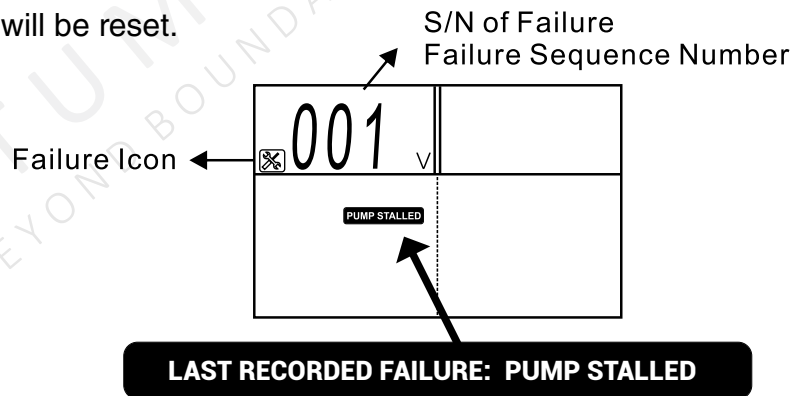

Accumulative running time display

The DYA-T07 control panel retains the duration it's been operating to enable the user to monitor the operating hours of the unit to ensure the unit is operating within it's designed conditions and for maintenance purposes.

To display the accumulative running time:

Press the **STORE** and **STOP** button simultaneously and hold until you hear a beep sound. Once you hear the beep sound the accumulative running time will display on the screen.

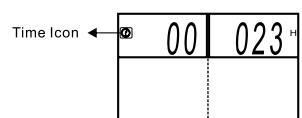

THE PUMP HAS RUN FOR 23 HOURS

PUMP CONTROLLER

DYA-T07 Trouble shooting guide



Error	Possible Cause	Solution
UNDER V (UNDER VOLTAGE)	The running voltage is lower than the calibrated voltage setting.	The control panel will restart the pump every 5 min until voltage is restored to normal
		If problem continues to occur report to power supply company.
OVER V (OVER VOLTAGE)	The running voltage is higher than the calibrated voltage setting.	The control panel will restart the pump every 5 min until voltage is restored to normal
		If problem continues to occur report to power supply company.
OVER LOAD	The running ampere is higher than the calibrated running ampere.	The control unit will attempt to restart the pump every 30 min.
	Operating unit windings might be damaged	If problem continues to occur the needs to be send in to your nearest technical facility.
PUMP NO CALIBRATION	The parameter calibration has not been set.	Set the parameter calibration according to steps on page 4.
DRY RUN	The liquid supply is below the operating units intake or block.	The control unit will attempt to restart every 30 min until the operating unit inlet is flooded.
PUMP STALLED	The running Amps of the operating unit exceeds the calibrated Amp with more than 200%	The operating unit needs to be sent in to your nearest technical facility for evaluation.
REPEATED START	The operating unit Starts more than 5 times per minute.	Check pressure tank precharge Check pressure tank bladder Check pressure switch settings Check pressure switch for defects